

FÖNSTER

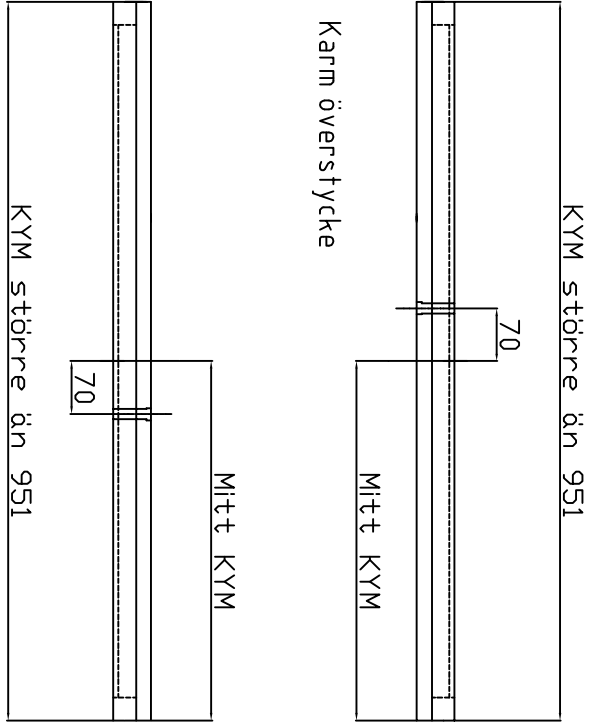

FÖRBORRNING FASTFÖNSTER

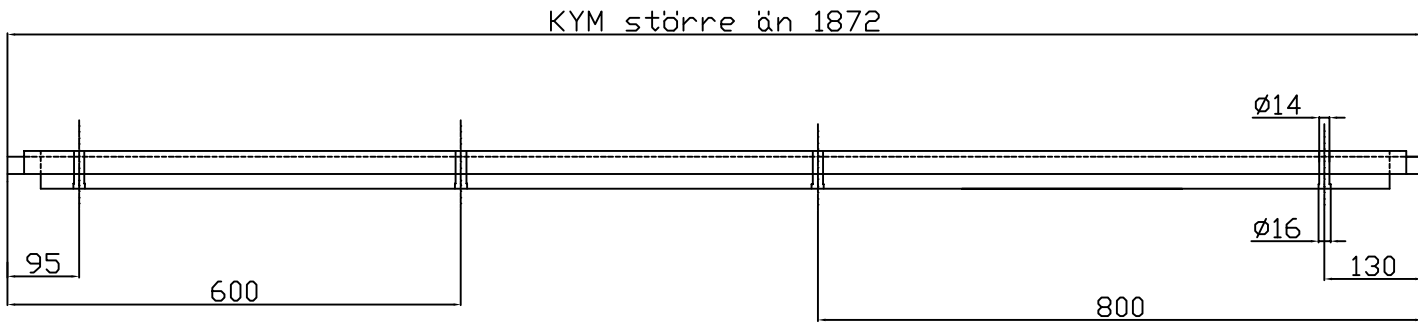
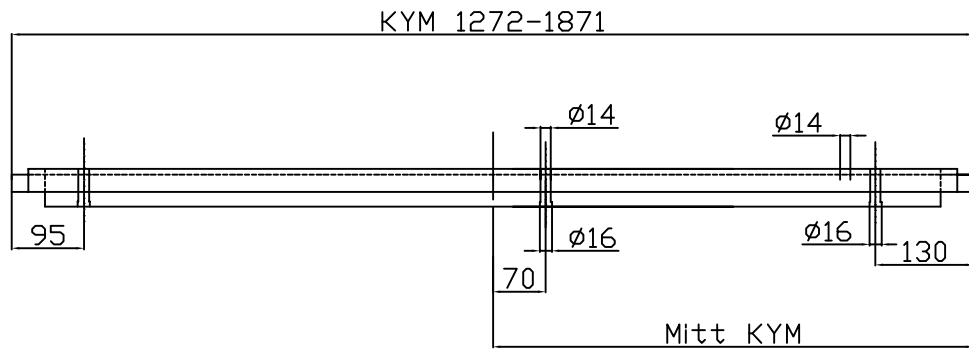
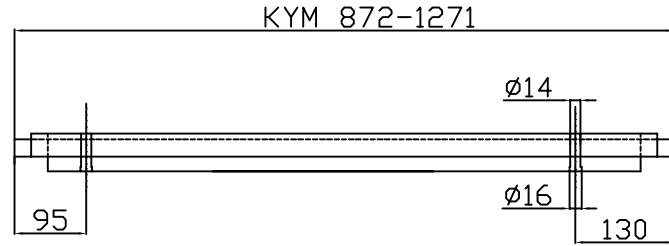
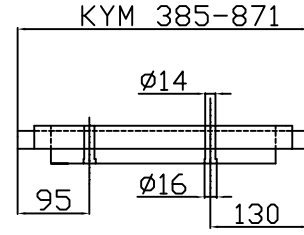
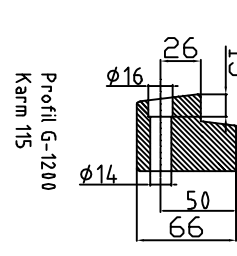
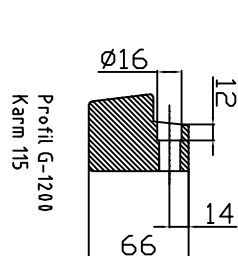
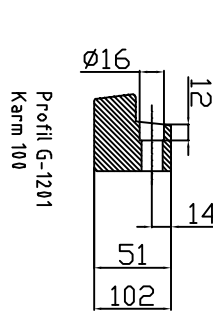
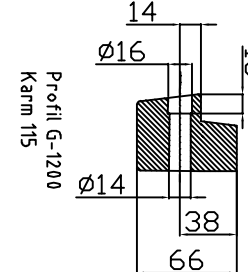
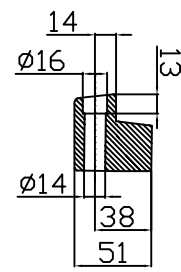

DÖRR

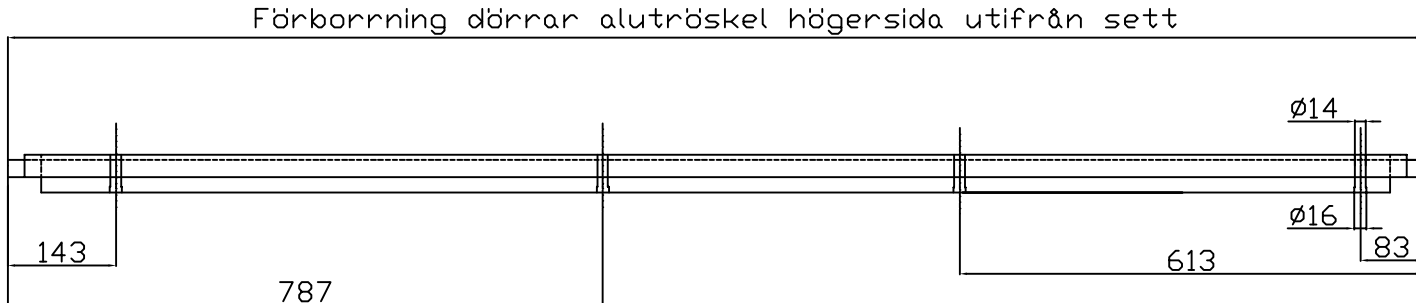
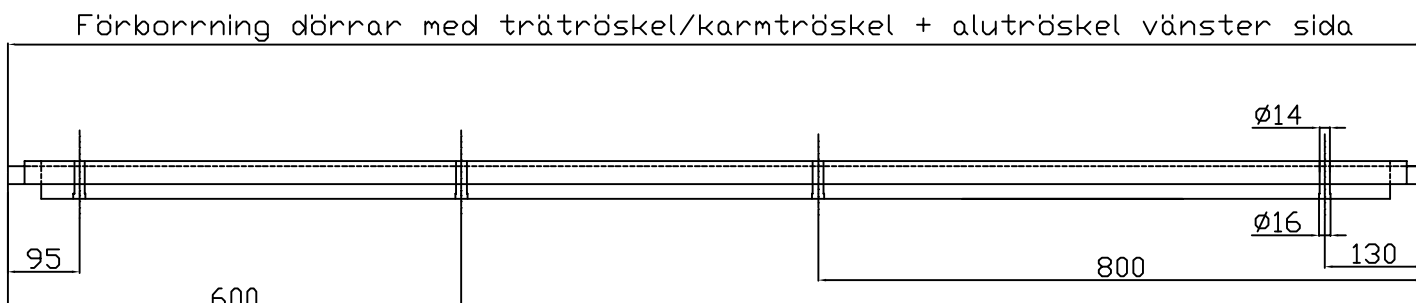

**Westcoast windows AB**

451 55 Uddevalla Sweden

Karmskruv	Scale	Designer	Date
		CK	190128

Förborrning karmskruv Vänstersida sett utifrån Högersida spegelvändes	REF.ND.	Rev
	DRAV.ND.	D
		015

NOTE	AM-ND.	ALTERATION	DATE	SIGN
------	--------	------------	------	------